



Earthquake Safety Fair Mandatory Soft Story Program

Matt Ralls and Chu Liu, DBI
June 15, 2017



Agenda

THE MANDATORY SOFT STORY RETROFIT PROGRAM

- What Is A Soft Story Building?
- Why Are Soft Story Buildings Considered Dangerous?
- What Does A Soft Story Seismic Retrofit Consist Of?
- Define Program Tiers And Status

TIER 3 (less than 15 units) - DUE Sept 15, 2017

- Four Steps To Compliance
- Resources For Information
- How Do I Find An Engineer
- Engineering Proposals
- Request Original Building Drawings
- Special Inspections
- What Happens For Non-compliance

TIER 4 (ground floor commercial or LF zone) - DUE Sept 15, 2018

- **ADA REQUIREMENTS**
- D.A. CHECKLIST (Information Sheet DA-02)
- Ordinance Accessible Business Entrance Program
- How Do I Find Contractors?



Resources

- Department of Building Inspection:
<http://sfdbi.org/SOFTSTORY>
- DBI Soft Story Information Desk
1660 Mission Street,
1st Floor, Window 10
softstory@sfgov.org
415-558-6699
- Structural Engineers Assoc. of
Northern California (SEAONC):
<http://www.seaonc.org/soft-story-faq>

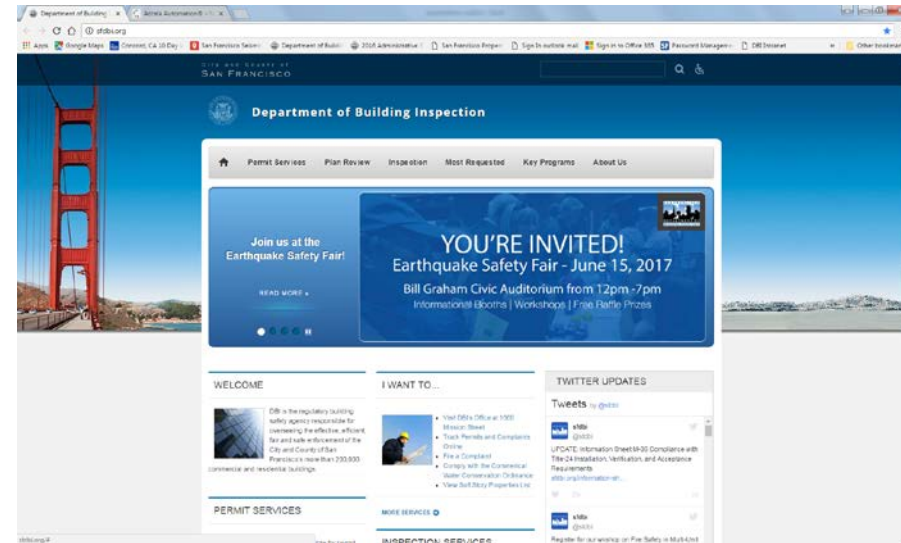

Visit DBI's Soft Story website

For the latest information, visit www.sfdbi.org/SOFTSTORY



For Property Owners



For Tenants



Received a Notice of Violation?



Frequently Asked Questions



For Design Professionals and Contractors



Finance Options



Resources



Code Enforcement Process

The Mandatory Soft Story Retrofit Program (MSSP)(Soft Story Ordinance)

- The United States Geological Survey (USGS) predicts a 63% chance another large earthquake will strike San Francisco in the next 30 years.
- The intensity of that event is expected to rival, if not exceed, those of the 1989 Loma Prieta Earthquake and the 1994 Northridge Earthquake.
- A 2009 report from Community Action Plan for Seismic Safety, a city panel charged with improving earthquake safety, found that buildings with no retrofitting are projected to have a 1-in-4 collapse rate during a serious quake, while those with minimum retrofitting have a 1-in-30 chance of falling down.
- Given the stakes, the board of supervisors enacted the soft story ordinance over 4 years ago to help ensure the safety of our residential occupants and resilience of San Francisco's housing stock.
- This legislation requires the retrofit of all older and larger, multi-family, wood frame, residential buildings that contain a soft story condition. These buildings house over 115,000 San Francisco residents and are susceptible to strong damage in an earthquake because of a weakness found in the buildings lower story.
- The ordinance's purpose is to mitigate soft story buildings' risk to damage and collapse due to strong earthquake ground shaking, and to thereby diminish the amount of uninhabitable housing following an earthquake disaster.

What is a “Soft Story Building”?



- a wood-framed building, constructed prior to 1978,
- Two or more stories over a basement or underfloor area that has any portion extending above grade
- containing five or more residential units,
- and story as illustrated in Figure 1.2
- A soft or weak story floor is a structure where the first story is substantially weaker and more flexible than the stories above due to lack of walls or frames at the first floor. Typically, these buildings contain large open areas for parking featuring large windows or garage doors at the ground level or commercial space such as restaurants or convenience stores on the first floor leaving the building highly vulnerable to damage in an earthquake.

Why Are “Soft Story Buildings” Considered Dangerous?

- Past earthquakes have demonstrated that soft story buildings are particularly vulnerable to severe damage or collapse in a major earthquake relative to other building types.
- Collapse itself poses a safety to risk to occupants. Additionally, collapse could ignite fires that threaten the safety of occupants and neighboring buildings.
- The City estimates 43% to 85% of soft story buildings will be uninhabitable following a major earthquake.
- Such widespread damage could displace 58,000 residents, 2,000 businesses, and the 7,000 employees associated with those businesses.³
- Devastation of this magnitude could impede the City's disaster recovery and future economic welfare.
- *Source: SEAONC, <http://www.seaonc.org/soft-story-faq>*

Figures 2 and 3 illustrate the characteristically dangerous behavior which soft story buildings can exhibit in a strong earthquake. These buildings were located in San Francisco, and they are shown in their post 1989 Loma Prieta Earthquake state. In Figure 2, note the second, third, and fourth floor stories are apparently unaffected by the earthquake, but the ground level story is laterally distorted, thereby exhibiting characteristic "soft story" behavior. The ground story distortion renders the building vulnerable to imminent collapse.



Source: SEAONC, <http://www.seaonc.org/soft-story-faq>

Figure 3 illustrates a building that has collapsed. The second and third stories are visible, but the ground level story is not. The second and third stories have collapsed onto the ground story.



What Does A Soft Story Seismic Retrofit Consist Of?

Plywood shear walls, anchor bolts and hold downs

- At cripple wall underfloor space and at existing walls.
- New walls harder to add at open parking.

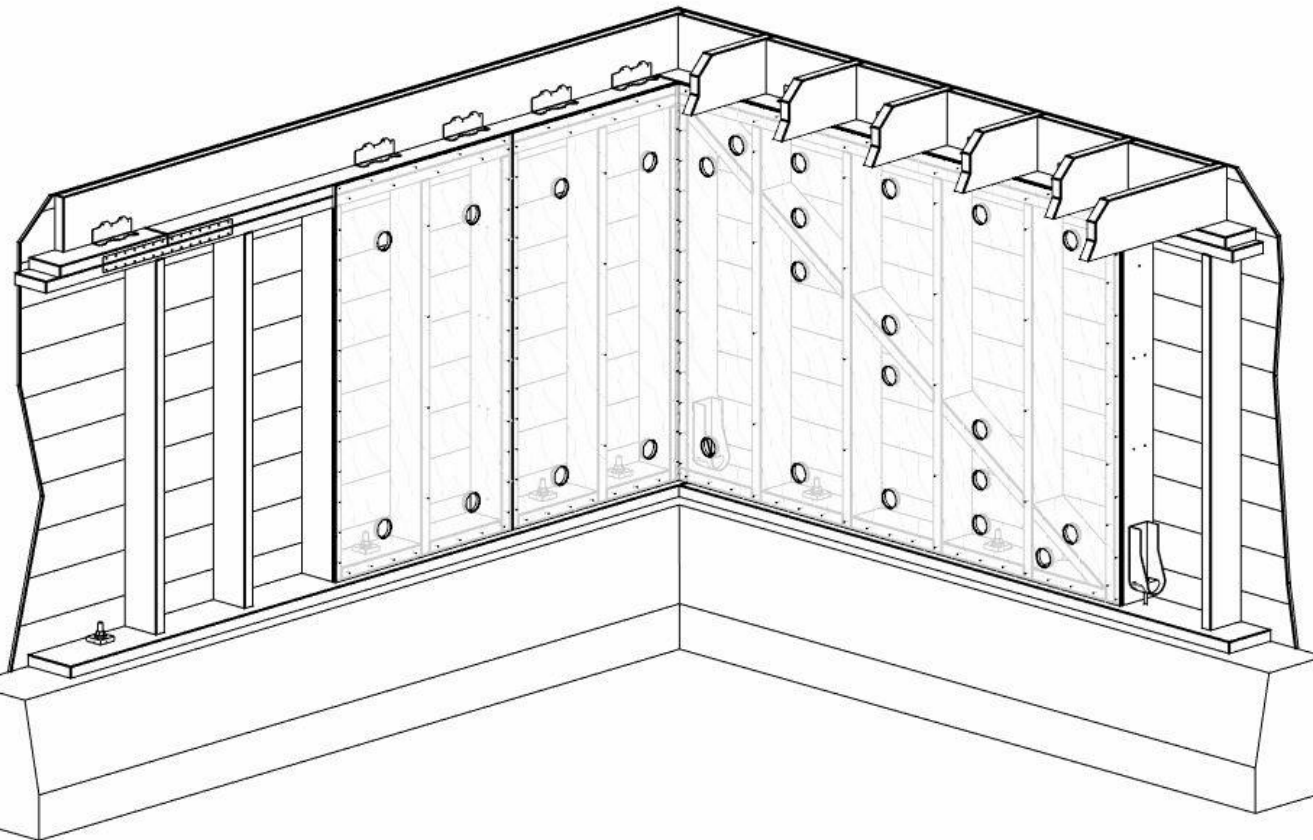

Moment Frames

- Span garage opening and parking
- Some proprietary frames reduce the need for field welding and bracing



Cantilever Columns

- Require more extensive foundation work but can eliminate beam above opening for lower headroom spaces

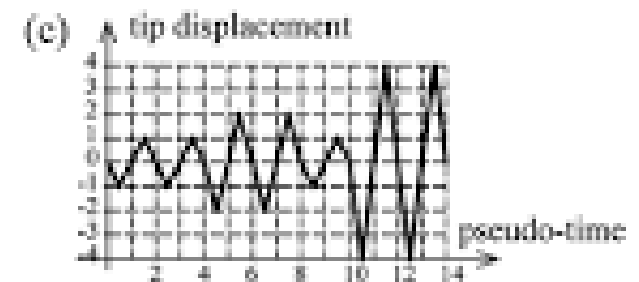
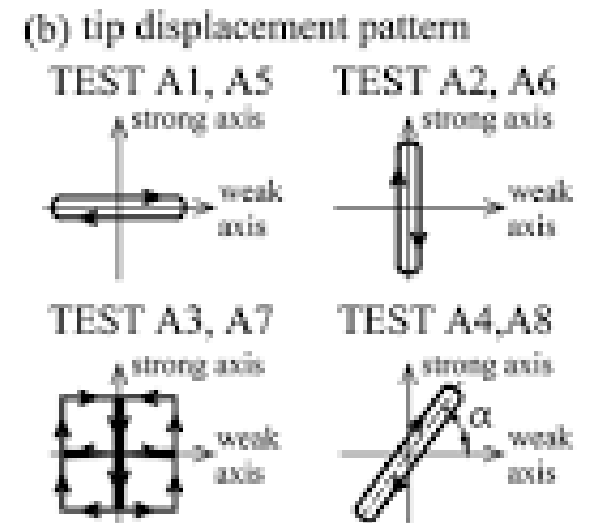
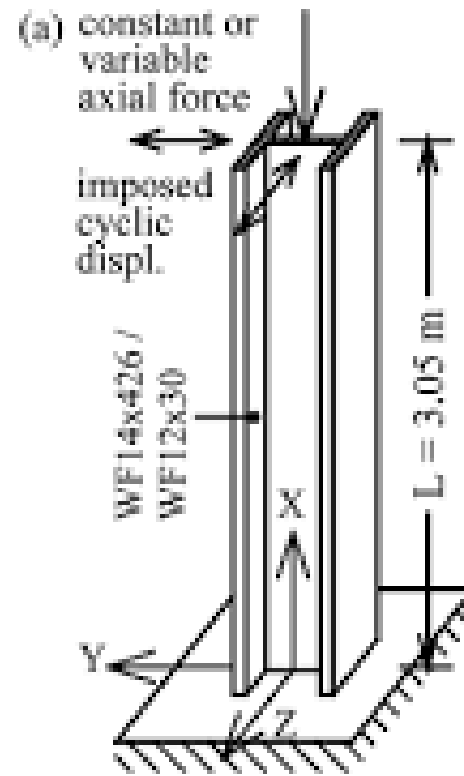

Collectors and Diaphragm Strengthening

- Collectors gather the lateral earthquake loads from a large area of a building — a floor diaphragm and deliver them to a structural element, such as a shear wall, that can resist the force.
- Collectors extend the full width of building.

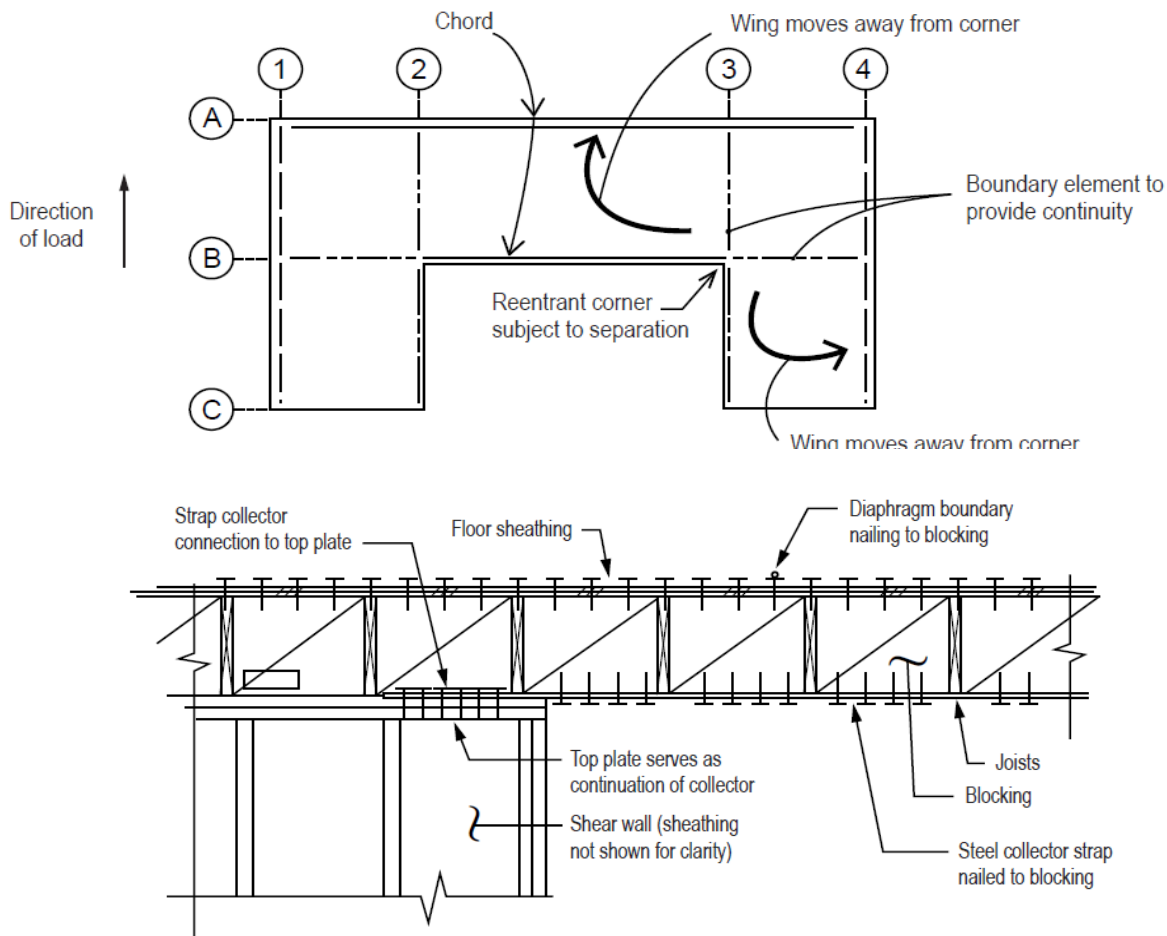

Figure 7-2. Steel strap and blocking providing a boundary member perpendicular to framing direction.



Properties Identified Under This Program Have Been Divided Into Four Tiers

Please find below a guide to property tiers:

- **Tier I** - Any building containing educational, assembly, or residential care facility uses (Building Code Occupancy E, A, R2.1, R3.1, or R4)
- **Tier II** - Any building containing 15 or more dwelling units
- **Tier III** - Any building not falling within another tier
- **Tier IV** - Any building containing ground floor commercial uses (Building Code Occupancy B or M), or any building in a mapped liquefaction zone. For information about liquefaction please visit the [City's Earthquake Safety Implementation Program \(ESIP\) website.](#)

Status of Program

- 4957 in program, (50%) submitted for permits, (23%) completed
- **Tier 1** - submit permit by 9/15/2015 (A,E, R2.1,3.1,4) = 6/6 (100% compliance)
- **Tier 2** - submit permit by 9/15/2016 (15 or more units) = 485/509 (95% compliance)
- **Tier 3** - submit permit by 9/15/2017 (all others) = 1661/3527 (47% in advance of compliance)
- **Tier 4** - submit permit by 9/15/2018 (B, M, liquifact.) = 328/915 (36% in advance of compliance)

Tier 3 (Less Than 15 Units)

– DUE Sept 15, 2017

- Submittal of Permit application with plans for seismic retrofit work.
- Engineers are busy, it may take 2 months to obtain permit drawings.
- Tier III retrofit must be signed off by 9/15/2019 (2 years).



Four Steps To Compliance

Follow the **FOUR STEPS** below to comply with permit requirements for the Mandatory Soft Story Program (MSSP).

- **STEP 1:** Work with a licensed design professional who specializes in seismic strengthening of buildings to develop a retrofiting plan.
 - Visit DBI website for lists of engineers who attended workshops
 - Visit SEAONC website for seismic & soft story engineers
 - Visit AIA website, Department of consumer affairs website, other websites, phonebooks
 - Call engineers, perform job walk, obtain proposals, check references and select design professional
 - Request original building plans (if available from DBI records retention). Discuss with design professional if desired.

How Do I Find An Engineer?

Visit: sfdbi.org/property-owners

SELECTING A DESIGN PROFESSIONAL AND CONTRACTOR

The City is legally unable to recommend engineers and contractors at this time, however you can visit these online resources for more information:

- Participating Vendors ESIP Earthquake Retrofit Fair - April 18, 2016
- Participating Vendors, ESIP Earthquake Retrofit Fair - January 28, 2014
- SEAONC also maintains a page that explains the value of hiring an engineer and how to hire an engineer.
- NEW - SEAONC Structural Engineer Referral List
- The State of California Department of Consumer Affairs provides a license search for structural engineers. Please click this link.
- The State of California Department of Consumer Affairs provides a license search for contractors. Please click this link.
- The State of California Department of Consumer Affairs maintains a website explaining the process of hiring a contractor. Please click this link.
- The American Institute of Architects, San Francisco (AIA) maintains a directory of firms available to public. Please click this link to access.
- Engineers, Architects, Contractors who have provided their contact information at our October 28 workshop.
- Engineers, Architects, Contractors who have provided their contact information at our November 21 workshop.

Structural Engineers Association of NorCal

www.seaonc.org/structural-engineer-referral-list



Structural Engineers Association OF NORTHERN CALIFORNIA

Enter your keywords

[Contact us](#) [Login](#) [Home](#)

[ABOUT SEAONC](#) [MEMBERSHIP](#) [COMMITTEES](#) [JOBS](#) [EVENTS](#) [PUBLIC INFORMATION](#) [NEWS & PUBLICATIONS](#) [SPONSORS](#)

Structural Engineer Referral List

City Firm Name

Search for a Structural Engineer based on your project type(s) and/or location. If you know the engineering firm's name, please enter it to obtain their contact information and project types.

The function of SEAONC's "Structural Engineer Referral List" is to assist individuals seeking to find Structural and Civil Engineers that specialize in specific areas of structural engineering. SEAONC does not endorse any individuals or companies, or assume liability for any claims or statements made by those advertising their services on this list. These individuals/companies have paid a fee to advertise their "For Hire" services on SEAONC's "Structural Engineer Referral List."

Those structural/civil engineers desiring to be listed here should [CLICK HERE](#). SEAONC member login is required.

UPCOMING EVENTS

Wednesday, May 31, 2017
May Short Course: Guidelines for Nonlinear Analysis - Latest Recommendations from the ATC 114 Project

Tuesday, June 6, 2017
June Dinner Meeting: Annual Business Meeting

Thursday, June 8, 2017
2017 SEAONC Summer Seminar: Examples from the Latest SEAOC Structural Seismic Design Manual

Thursday, June 15, 2017
2017 SEAONC Summer Seminar: Examples from the Latest SEAOC Structural Seismic Design Manual

[VIEW FULL CALENDAR](#)

LATEST NEWS & ANNOUNCEMENTS

Mar, 13, 2017

Engineering Proposals

- Scope of Work, Cost and Schedule

Scope of work should include following:

- site visits and evaluation,
- exploratory demo (if req'd)
- design calculations and construction drawings,
- obtaining permits (or who will)
- response to plan review comments,
- structural observations,
- plan revisions due to field conditions and obtaining revision permit,
- review of third party testing and final letter.

See A Guide for Consumers by The Board for Professional Engineers and Land Surveyors, part of the California Department of Consumer Affairs:

www.bpelsg.ca.gov/pubs/consumer_guide.pdf

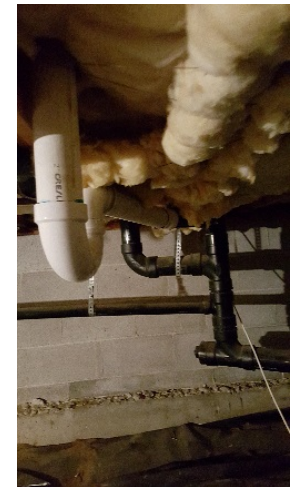
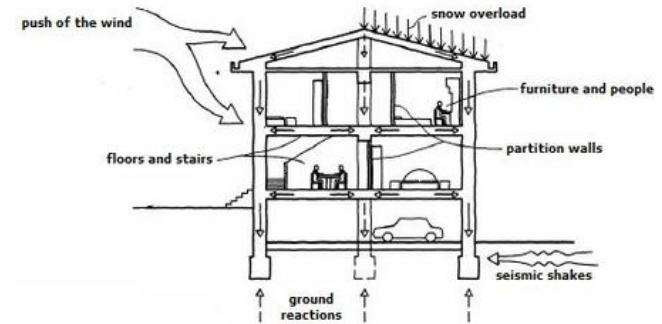

Request Original Building Drawings

- (if available) from DBI records management division (may take several weeks) <http://sfdbi.org/rmd>.

- DBI requires floor plans of target story and typical floor above. This may assist your engineer and potentially reduce cost for field measurement.

The screenshot shows the website sfdbi.org/property-owners#Steps to Comply. The navigation menu includes: Home, Permit Services, Plan Review, Inspection, Most Requested, **Key Programs**, and About Us. A red arrow points to the 'Key Programs' menu item. Below the navigation, the page title is 'For Property Owners' under the 'Mandatory Soft Story Program'. The main content area contains text about the program's purpose and a list of resources. A red arrow points to the 'Records Management Division' link in the 'RESOURCES' section, which includes the email Email softstory@sfgov.org. The right sidebar contains 'KEY PROGRAMS' and 'For Property Owners' sections with various links like 'Addition of Dwelling Units (ADU)', 'Emergency Preparedness', and 'Soft Story FAQ'. At the bottom, there is a 'SHARE THIS' button, a language selector, and a 'STAY CONNECTED' section.

Four Steps To Compliance

STEP 2: Visit DBI at 1660 Mission Street to file the permit application.

- Complete Permit Application Form No. 3/8 (pink application form)
- Submit structural upgrade plans & calculations by licensed design professional (2 sets wet stamp & signature required on first sheet, all others may be electronically stamped and signature)
- Disability access checklist if there is a ground floor commercial space. Not required for residential only buildings.
- Bring design professional who drew up plans with you when filing OTC. This will cut down on permit processing time.
- Once approved and you've paid for permit fees, you can now move forward with your construction plans.

Four Steps To Compliance

STEP 3: Proceed with work accordingly once permit is issued.

- Notify tenants, if you haven't already done so.
- Make sure to get all inspections approved as required by code. Be mindful of inspection schedule as work progresses.
- Owner required to hire special inspector (third party)

STEP 4: Obtain Certificate of Final Completion and submit to DBI staff to complete compliance.

- You will need to request the issuance of the Certificate of Final Completion (CFC) once the job card is signed off after a Final Inspection by the building inspector. A copy of the CFC document will then need to be submitted to the Soft Story Counter Window #8 on the 1st Floor at 1660 Mission Street, or emailed to softstory@sfgov.org in order to complete your participation in the Mandatory Seismic Retrofit Program.

Special Inspections



- The building code requires certain types of work to be inspected by a Special Inspector as a quality assurance measure. The Special Inspector must be retained by the owner. Special Inspection Items should be listed on the building plans as well as the 'statement of special inspection'. The building code prohibits the contractor from hiring Special Inspectors. The DBI maintains a list of firms prequalified to provide Special Inspection.

City and County of San Francisco
Department of Building Inspection



Edwin M. Lee, Mayor
Tom C. Hui, S.E., C.B.O., Director

NOTICE

SPECIAL INSPECTION REQUIREMENTS

Please note that the Special Inspections shown on the approved plans and checked on the Special Inspections form issued with the permit are required for this project. The employment of special inspectors is the direct responsibility of the owner or the engineer/architect of record acting as the owner's representative.

These special inspections are required *in addition to* the called inspections performed by the Department of Building Inspection. The name of the special inspector shall be furnished to the district building inspector prior to start of work for which special inspection is required.

For questions regarding the details or extent of required inspection or tests, please call the Plan Checker assigned to this project or **415-558-6132**. If there are any field problems regarding special inspection, please call your District Building Inspector or 415-558-6570.

Before final building inspection is scheduled, documentation of special inspection compliance must be submitted to and approved by the Special Inspection Services staff. To avoid delays in this process, the project owner should request final compliance reports from the architect or engineer of record and/or special inspection agency soon after the conclusion of work requiring special inspection. **The permit will not be finalized without compliance with the special inspection requirements.**

STRUCTURAL OBSERVATION REQUIREMENTS

Structural observation shall be provided as required per Section 1704.5. **The building permit will not be finalized without compliance with the structural observation requirements.**

Special Inspection Services Contact Information

- Telephone: (415) 558-6132
- Fax: (415) 558-6474
- Email: dbi.specialinspections@sfgov.org
- In person: 3rd floor at 1660 Mission Street

Note: We are moving towards a 'paperless' mode of operation. All special inspection submittals, including final letters, may be emailed (preferred) or faxed. We will also be shifting to a paperless fax receipt mode.

SPECIAL INSPECTION AND STRUCTURAL OBSERVATION A COPY OF THIS DOCUMENT SHALL BE KEPT WITH THE APPROVED STRUCTURAL DRAWING SET

JOB ADDRESS _____ APPLICATION NO. _____ ADDENDUM NO. _____

OWNER NAME _____ OWNER PHONE NO. (_____) _____

Employment of Special Inspection is the direct responsibility of the OWNER, or the engineer/architect of record acting as the owner's representative. Special inspector shall be one of those as prescribed in Sec.1704. Name of special inspector shall be furnished to DBI District Inspector prior to start of the work for which the Special Inspection is required. Structural observation shall be performed as provided by Section 1704.5. A preconstruction conference is recommended for owner/builder or designer/builder projects, complex and highrise projects, and for projects utilizing new processes or materials.

In accordance with Sec. 1701;1703;1704; 1705 (2013 SFBC), Special Inspection and/or testing is required for the following work:

- | | | |
|---|--|---|
| 1. <input type="checkbox"/> Concrete (Placement & sampling | 6. <input type="checkbox"/> High-strength bolting | 18. Bolts installed in existing concrete masonry: |
| 2. <input type="checkbox"/> Bolts installed in concrete | 7. <input type="checkbox"/> Structural masonry | <input type="checkbox"/> Concrete <input type="checkbox"/> Masonry |
| 3. <input type="checkbox"/> Special moment-Resisting concrete frame | 8. <input type="checkbox"/> Reinforced gypsum concrete | <input type="checkbox"/> Pull/torque tests per SFBC Sec.1607C & 1615C |
| 4. <input type="checkbox"/> Reinforcing steel and prestressing tendons | 9. <input type="checkbox"/> Insulating concrete fill | 19. <input type="checkbox"/> Shear walls and floor systems used as shear diaphragms |
| 5. Structural welding: | 10. <input type="checkbox"/> Sprayed-on fireproofing | 20. <input type="checkbox"/> Holdowns |
| A. Periodic visual inspection | 11. <input type="checkbox"/> Piling, drilled piers and caissons | 21. Special cases: |
| <input type="checkbox"/> Single pass fillet welds 5/16" or smaller | 12. <input type="checkbox"/> Shotcrete | <input type="checkbox"/> Shoring |
| <input type="checkbox"/> Steel deck | 13. <input type="checkbox"/> Special grading, excavation and filling (Geo. Engineered) | <input type="checkbox"/> Underpinning: <input type="checkbox"/> Not affecting adjacent property |
| <input type="checkbox"/> Welded studs | 14. <input type="checkbox"/> Smoke-control system | <input type="checkbox"/> Affecting adjacent property: PA _____ |
| <input type="checkbox"/> Cold formed studs and joists | 15. <input type="checkbox"/> Demolition | <input type="checkbox"/> Others _____ |
| <input type="checkbox"/> Stair and railing systems | 16. <input type="checkbox"/> Exterior Facing | 22. <input type="checkbox"/> Crane safety (Apply to the operation of Tower cranes on highrise building) (Section 1705.21) |
| <input type="checkbox"/> Reinforcing steel | 17. Retrofit of unreinforced masonry buildings: | 23. <input type="checkbox"/> Others: "As recommended by professional of record" _____ |
| <input type="checkbox"/> All other welding (NDT exception: Fillet weld) | <input type="checkbox"/> Testing of mortar quality and shear tests | |
| <input type="checkbox"/> Reinforcing steel; and <input type="checkbox"/> NDT required | <input type="checkbox"/> Inspection of repointing operations | |
| <input type="checkbox"/> Moment-resisting frames | <input type="checkbox"/> Installation inspection of new shear bolts | |
| <input type="checkbox"/> Others _____ | <input type="checkbox"/> Pre-installation inspection for embedded bolts | |
| | <input type="checkbox"/> Pull/torque tests per SFBC Sec.1607C & 1615C | |

24. Structural observation per Sec. 1704.5 (2013 SFBC) for the following: Foundations Steel framing
 Concrete construction Masonry construction Wood framing
 Other: _____

25. Certification is required for: Glu-lam components

Prepared by: _____ Phone: (_____) _____
Engineer/Architect of Record

Required information:
FAX: (_____) _____ Email: _____

Review by: _____ Phone: (415) 558-_____
DBI Engineer or Plan Checker

APPROVAL (Based on submitted reports.)

DATE _____ DBI Engineer or Plan Checker / Special Inspection Services Staff

QUESTIONS ABOUT SPECIAL INSPECTION AND STRUCTURAL OBSERVATION SHOULD BE DIRECTED TO:
Special Inspection Services (415) 558-6132, or dbi.specialinspections@sfgov.org ; or FAX (415) 558-6474

Failure to Comply Will Result In

CODE ENFORCEMENT

Failure to comply by the due dates may result in code enforcement proceedings and this placard getting posted on your property.

DO NOT REMOVE UNDER PENALTY OF LAW! DO NOT REMOVE UNDER PENALTY OF LAW! DO NOT REMOVE UNDER PENALTY OF LAW!



The San Francisco Department of Building Inspection - Tom Hui, S.E., C.B.O., Director
SFBC Section 3405B.6.1

EARTHQUAKE WARNING!

This Building is in Violation of the Requirements of the San Francisco Building Code Regarding Earthquake Safety.

The owner(s) of this building have not complied with the Mandatory Soft Story Retrofit Program, as required by SFBC Chapter 34B. Please contact the Department of Building Inspection at softstory@sfgov.org or (415) 558-6699 or www.sfdbi.org/softstory.

地震警告!

這棟樓宇違反三藩市建築條例
有關地震安全的要求。

根據三藩市建築條例第34B章，
本棟樓宇業主未遵守軟層建築物
防震加固計劃強制規定。

請立即與樓宇檢查部連絡，
電郵: softstory@sfgov.org，
電話: (415) 558-6699

或網址: www.sfdbi.org/softstory。

¡ADVERTENCIA DEL TERREMOTO!

Este edificio está en la violación de los requisitos del Código de construcción de San Francisco en cuanto a la seguridad del terremoto.

El propietario o los propietarios de este edificio no ha(n) cumplido con el Programa Obligatorio de Acondicionamiento de Pisos (Mandatory Soft Story Retrofit Program), según lo requiere el Código de Edificios de San Francisco Capítulo 34B (SFBC Chapter 34B). Favor comunicarse con el Departamento de Inspección de Edificios (Department of Building Inspection) a: softstory@sfgov.org o (415) 558-6699 o www.sfdbi.org/softstory.



DO NOT REMOVE UNDER PENALTY OF LAW! DO NOT REMOVE UNDER PENALTY OF LAW! DO NOT REMOVE UNDER PENALTY OF LAW!

Tier 4 (with Ground Floor Commercial or Liquefaction Zone)

Wood-Frame Seismic Retrofit Program Compliance Timeline & Tier

Compliance Tier	Submittal of Permit Application with Plans for Seismic Retrofit Work	Completion of Work and Issuance of Certificate of Final Completion
1	September 15, 2015	September 15, 2017
2	September 15, 2016	September 15, 2018
3	September 15, 2017	September 15, 2019
4	September 15, 2018	September 15, 2020

Tier 4 (with Ground Floor Commercial or Liquefaction Zone)

- Occupancy B & M require separate permits –one for the commercial space and one for residential space (project cost allocated by floor area)
- 20% of the commercial project cost to be used for accessibility improvement for ground floor commercial areas (must include D.A checklist with plans)
- Get started now to schedule work hours & work area impacting operations.

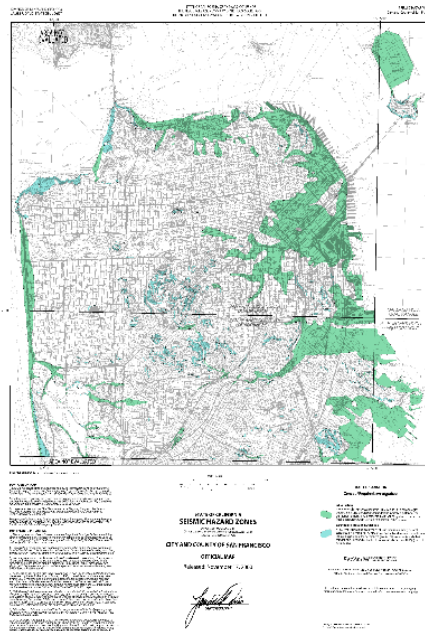

Commercial Portion – Include D.A. Checklist - + 20% ADA compliance on commercial portion – due to tenant capital cost passthrough



D.A. CHECKLIST (p. 1 of 2): The address of the project is: _____

For ALL tenant improvement projects in commercial use spaces, both pages of this checklist are required to be reproduced on the plan set **and signed**.

- The proposed use of the project is _____ (e.g. Retail, Office, Restaurant, etc.)
- Describe the area of remodel, including which floor: _____
- The construction cost of this project **excluding disabled access upgrades to the path of travel** is \$ _____, which is: (check one) more than / less than the Accessibility Threshold amount of **\$150,244.00** based on the "2013 ENR Construction Cost Index" (The cost index & threshold are updated annually).
- Is this a City project and/or does it receive any form of public funding? Check one: Yes / No. Note: If Yes, then see Step 3 on the Instructions page of the Disabled Access Upgrade Compliance Checklist package for additional forms required.

Conditions below must be fully documented by accompanying drawings

5. Read A through D below carefully and check the most applicable boxes. Check one box only:

<input type="checkbox"/> A: All existing conditions serving the area of remodel fully comply with access requirements. No further upgrades are required: Fill out page 2 of D.A. Checklist
<input type="checkbox"/> B: Project Adjusted cost of construction is greater than the current valuation threshold: Fill out and attach page 2 of D.A. Checklist and any other required forms to plans
<input type="checkbox"/> C: Project adjusted cost of construction is less than or equal to the current valuation threshold: List items that will be upgraded on Form C. All other items shall be checked on page 2 of the D.A. Checklist in the "Not required by code" column.
<input type="checkbox"/> D: Proposed project consists entirely of Barrier removal: Fill out and attach Barrier removal form to Plans
<input type="checkbox"/> E: Proposed project is minor revision to previously approved permit drawings only. (Note: This shall NOT be used for new or additional work) Provide previously approved permit application here: _____. Description of revision: _____

CBC chapter 2 section 202 Definitions:

Technically Infeasible. An alteration of a building or a facility, that has little likelihood of being accomplished because the existing structural conditions require the removal or alteration of a load-bearing member that is an essential part of the structural frame, or because other existing physical or site constraints prohibit modification or addition of elements, spaces or features that are in full and strict compliance with the minimum requirements for new construction and which are necessary to provide accessibility.

Unreasonable Hardship. When the enforcing agency finds that compliance with the building standard would make the specific work of the project affected by the building standard infeasible, based on an overall evaluation of the following factors:

- The cost of providing access.
- The cost of all construction contemplated.
- The impact of proposed improvements on financial feasibility of the project.
- The nature of the accessibility which would be gained or lost.
- The nature of the use of the facility under construction and its availability to persons with disabilities

The details of any Technical Infeasibility or Unreasonable Hardship shall be recorded and entered into the files of the Department. All Unreasonable Hardships shall be ratified by the AAC.

Form C: DISABLED ACCESS 20% RULE

This form is only required for projects equal to or under the valuation threshold when box "C" is checked off on the D.A. Checklist and is for providing an itemized list of the estimated costs for the expenditures used for disabled access upgrades for this project. Reproduce this form along with the D.A. Checklist and any required form(s) on the plans.

Based on CBC Section 11B-202.4 Exception 8, only projects with a construction cost less than or equal to the valuation threshold (current ENR Construction Cost Index Amount) are eligible for the 20% rule. In choosing which accessible elements to provide, priority should be as listed on p. 2 of the D.A. Checklist.

In general, projects valued over the threshold are not eligible for the 20% rule (see CBC 11B-202.4 Exceptions 1 through 8 for other exceptions).

CBC Section 11B-202.4, Exception 9 (*abbreviated*): In alteration projects involving buildings & facilities previously approved & built without elevators, areas above & below the ground floor are subject to the 20% disproportionality provisions described in Exception 8, even if the value of the project exceeds the valuation threshold in Exception 8. Refer to the Code for the types of buildings & facilities that qualifies for this 20% disproportionality provisions when project valuation is over the threshold.

	Contractor's Estimated Cost	DBI Revised Cost
A) Cost of Construction: (Excluding Alterations to the Path of Travel as required by 11B-202.4)	\$ _____	\$ _____
B) 20% of A) :	\$ _____	\$ _____

List the Upgrade Expenditures and their respective construction cost below:

	Contractor's Estimated Cost	DBI Revised Cost
1. _____	\$ _____	\$ _____
2. _____	\$ _____	\$ _____
3. _____	\$ _____	\$ _____
4. _____	\$ _____	\$ _____
5. _____	\$ _____	\$ _____
6. _____	\$ _____	\$ _____
7. _____	\$ _____	\$ _____
8. _____	\$ _____	\$ _____
9. _____	\$ _____	\$ _____

Total Upgrade Expenditures Should be approximately equal to, but not to exceed, Line B	\$ _____	\$ _____
---	----------	----------

New Ordinance: 51-16 Accessible Business Entrance Program

Requires any existing building with a place of public accommodation either to have all primary entries and path of travel into the building accessible by persons with disabilities or to receive from the City a determination of equivalent facilitation, technical infeasibility, or unreasonable hardship (submit checklist by 5/22/18, all categories complete by 2/22/2021).

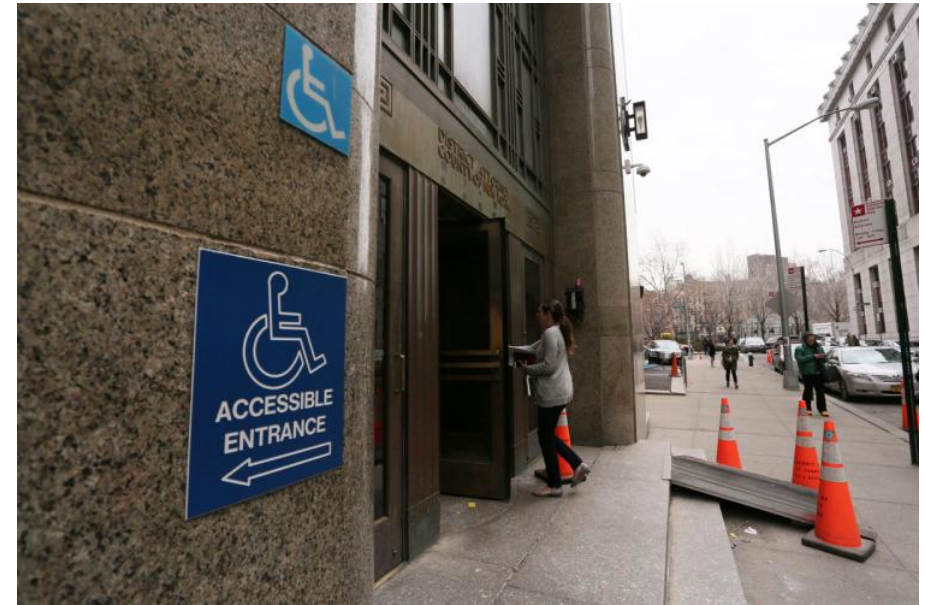
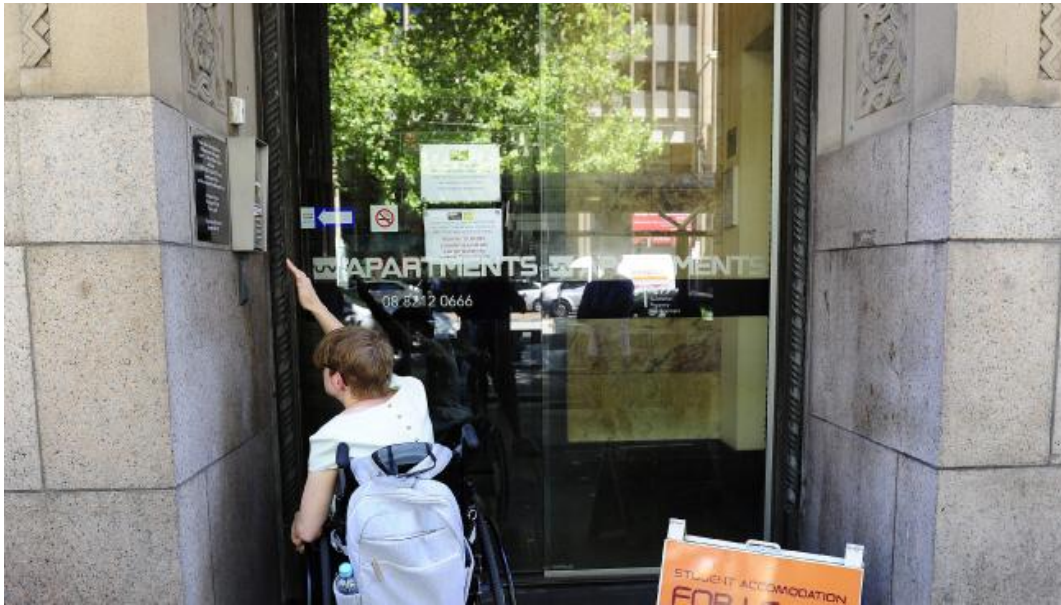

How Do I Find Contractors?

<http://sfdbi.org/property-owners>

- **SELECTING A DESIGN PROFESSIONAL AND CONTRACTOR**
- The City is legally unable to recommend engineers and contractors at this time, however you can visit these online resources for more information:
- [Participating Vendors ESIP Earthquake Retrofit Fair - June 15, 2017 \(to be posted\)](#)
- [Participating Vendors ESIP Earthquake Retrofit Fair - April 18, 2016](#)
- [Participating Vendors, ESIP Earthquake Retrofit Fair - January 28, 2014](#)
- The State of California Department of Consumer Affairs provides a license search for contractors. Please click this [link](#).
- The State of California Department of Consumer Affairs maintains a website explaining the process of hiring a contractor. Please click this [link](#).
- [Engineers, Architects, Contractors](#) who have provided their contact information at our October 28 workshop.(2013)
- [Engineers, Architects, Contractors](#) who have provided their contact information at our November 21 workshop.(2013)



Websites

WHAT DOES A SOFT STORY SEISMIC RETROFIT CONSIST OF?	http://www.seaonc.org/soft-story-faq
RESOURCES FOR INFORMATION	http://sfdbi.org/SOFTSTORY
HOW DO I FIND AN ENGINEER	http://sfdbi.org/property-owners http://seaonc.org/structural-engineer-referral-list
ENGINEERING PROPOSALS	http://www.bpelsg.ca.gov/pubs/consumer_guide.pdf
REQUEST ORIGINAL BUILDING DRAWINGS	http://sfdbi.org/rmd
WHAT HAPPENS FOR NON-COMPLIANCE	Code Enforcement Section at 415-558-6116
D.A. CHECKLIST (information sheet DA-02)	http://sfdbi.org/information-sheets
ORDINANCE ACCESSIBLE BUSINESS ENTRANCE PROGRAM	http://sfdbi.org/file/11614
HOW DO I FIND CONTRACTORS?	http://sfdbi.org/property-owners
Seismic Safety Construction Exclusion Form	http://sfassessor.org/tax-savings/exclusions/earthquake-retrofit
Rent board - apply for capital cost pass through	http://sfrb.org
City is offering a public financing option through AllianceNRG/Deutsche Bank	https://allianceng.com/retail/

Contact Us

Presenters:

Matt Ralls and Chu Liu of Plan Review Services

- DBI Soft Story Information Desk
1660 Mission Street,
1st Floor, Window 10
softstory@sfgov.org
415-558-6699
- Robert Chun, Program Manager























17. How much will it cost to seismically strengthen my soft-story building?

The cost will vary widely depending upon the level of the hazard and needed seismic upgrade work. Building owner will have to consult a licensed civil or structural engineer, or architect, who specializes in seismic strengthening of buildings to develop a retrofitting plan, and bids may be obtained from licensed contractors.

Through the Community Action Plan for Seismic Safety (CAPSS) analysis, it is believed that these retrofits will cost between \$60,000 and \$130,000, depending on the building size. Please visit our [Soft Story Financing Page](#) for more details about financing.

18. What is the cost of building permit application? Is it a fix fee or a percentage of construction costs?

Cost of permit is a percentage of construction costs per San Francisco Building Code Section 110A.

19. I am an owner of a soft-story building, but can't afford to retrofit my building. What are my options?

The City is offering a public financing option through AllianceNRG/Deutsche Bank for property owners wishing to finance both mandatory and voluntary seismic retrofits. [Click here for finance option information.](#)

20. Will tenants have to move out during retrofit?

If asked to move out, tenants should contact the Rent Control Board at (415) 252-4602 for more information. [Click here for more tenant information.](#)

21. Can rent be raised to cover the costs of the required retrofit?

All work within the scope of this ordinance, as certified per San Francisco Rent Board procedures governing “Seismic Work Required by Law”, will be subject to related pass-through regulation and allowances. This work may be passed along 100%. Although, if tenants are facing hardship, they may apply for the hardship appeal process for pass-through. For further questions, please contact Rent Control Board at 415-252-4602. [Click here for more tenant information.](#)

6. Where can I park during a retrofit?

To ease the burden of parking disruption Earthquake Safety Implementation Program (ESIP) worked directly with the San Francisco Rent Board to develop a piece of legislation that clarifies the process of compensating the tenant for the loss of parking for both building owner and tenant alike. Overall, this legislation stipulates that in the case where parking has a specified value in the lease, that the tenant is due that amount in compensation for their lost parking. In the case where parking has not been assigned a leased amount, the tenant will be due replacement value for the parking not to exceed 15% of the tenant's monthly base rent. For more information, click [here](#).